



**TAOS Inc.**

**is now**

**ams AG**

The technical content of this TAOS datasheet is still valid.

**Contact information:**

**Headquarters:**

ams AG

Tobelbaderstrasse 30

8141 Unterpremstaetten, Austria

Tel: +43 (0) 3136 500 0

e-Mail: [ams\\_sales@ams.com](mailto:ams_sales@ams.com)

Please visit our website at [www.ams.com](http://www.ams.com)

## Features

- **Color Light Sensing**
  - Programmable Analog Gain, Integration Time, and Interrupt Function with Upper and Lower Thresholds
  - Resolution Up to 16 Bits
  - Very High Sensitivity — Ideally Suited for Operation Behind Dark Glass
  - Up to 1,000,000:1 Dynamic Range
- **Low Power Wait State**
  - 65  $\mu$ A Typical Current
  - Wait Timer is Programmable from 2.4 ms to > 7 Seconds
- **I<sup>2</sup>C Interface Compatible**
  - Up to 400 kHz (I<sup>2</sup>C Fast Mode)
- **Dedicated Interrupt Pin**
- **Pin and Register Set Compatible with the TCS3x7x Family of Devices**
- **Small 2 mm  $\times$  2.4 mm Dual Flat No-Lead Package**
- **Sleep Mode — 2.5  $\mu$ A Typical Current**

PACKAGE FN  
DUAL FLAT NO-LEAD  
(TOP VIEW)

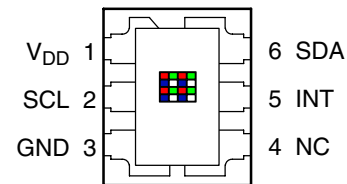

Package Drawing Not to Scale

## Applications

- Color Temperature Sensing
- RGB LED Backlight Control
- Color Display Closed-Loop Feedback Control
- Ambient Light Sensing for Display Brightness Control
- Industrial Process Control
- Medical Diagnostics

## End Products and Market Segments

- HDTVs, Mobile Handsets, Tablets, Laptops, Monitors, PMP (Portable Media Players)
- Medical Instrumentation
- Consumer Toys
- Industrial/Commercial Lighting

## Description

The TCS3471 family of devices provides red, green, blue, and clear light sensing (RGBC) that detects light intensity under a variety of lighting conditions and through a variety of attenuation materials. An internal state machine provides the ability to put the device into a low power mode in between RGBC measurements providing very low average power consumption.

The TCS3471 is directly useful in lighting conditions containing minimal IR content such as LED RGB backlight control, reflected LED color sampler, or fluorescent light color temperature detector. With the addition of an IR blocking filter, the device is an excellent ambient light sensor, color temperature monitor, and general purpose color sensor.

# TCS3471 COLOR LIGHT-TO-DIGITAL CONVERTER

TAOS115 – MARCH 2011

## Functional Block Diagram

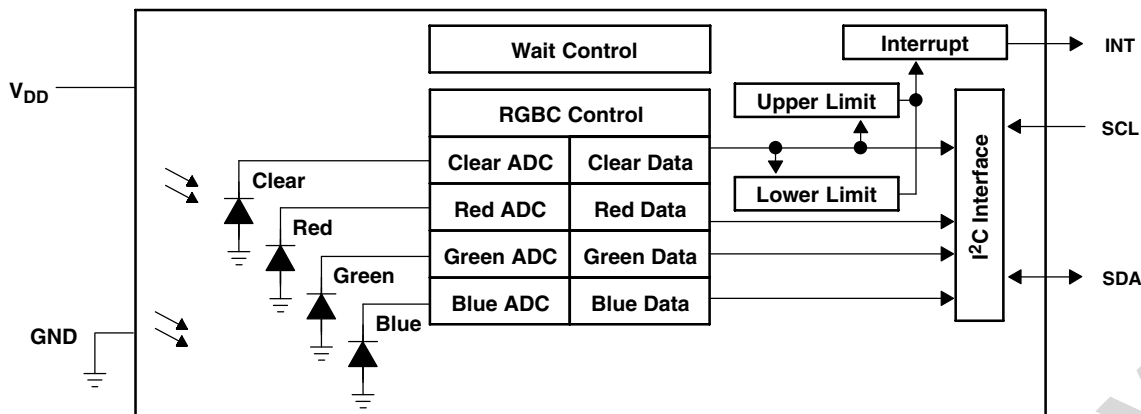

## Detailed Description

The TCS3471 light-to-digital device contains a  $4 \times 4$  photodiode array, integrating amplifiers, ADCs, accumulators, clocks, buffers, comparators, a state machine, and an I<sup>2</sup>C interface. The  $4 \times 4$  photodiode array is composed of red-filtered, green-filtered, blue-filtered, and clear photodiodes — four of each type. Four integrating ADCs simultaneously convert the amplified photodiode currents to a digital value providing up to 16 bits of resolution. Upon completion of the conversion cycle, the conversion result is transferred to the data registers. The transfers are double-buffered to ensure that the integrity of the data is maintained. Communication to the device is accomplished through a fast (up to 400 kHz), two-wire I<sup>2</sup>C serial bus for easy connection to a microcontroller or embedded controller.

The TCS3471 provides a separate pin for level-style interrupts. When interrupts are enabled and a pre-set value is exceeded, the interrupt pin is asserted and remains asserted until cleared by the controlling firmware. The interrupt feature simplifies and improves system efficiency by eliminating the need to poll a sensor for a light intensity value. An interrupt is generated when the value of an RGBC conversion exceeds either an upper or lower threshold. In addition, a programmable interrupt persistence feature allows the user to determine how many consecutive exceeded thresholds are necessary to trigger an interrupt.

## Terminal Functions

| TERMINAL NAME   | NO. | TYPE | DESCRIPTION   |
|-----------------|-----|------|---|
| GND             | 3   |      | Power supply ground. All voltages are referenced to GND.                                      |
| INT             | 5   | O    | Interrupt — open drain.   |
| NC              | 4   |      | Do not connect  |
| SCL             | 2   | I    | I <sup>2</sup> C serial clock input terminal — clock signal for I <sup>2</sup> C serial data. |
| SDA             | 6   | I/O  | I <sup>2</sup> C serial data I/O terminal — serial data I/O for I <sup>2</sup> C .            |
| V <sub>DD</sub> | 1   |      | Supply voltage.   |

### Available Options

| DEVICE    | ADDRESS | PACKAGE – LEADS | INTERFACE DESCRIPTION                             | ORDERING NUMBER |
|-----------|---------|-----------------|---|-----------------|
| TCS34711† | 0x39    | FN–6            | I <sup>2</sup> C Vbus = V <sub>DD</sub> Interface | TCS34711FN      |
| TCS34713† | 0x39    | FN–6            | I <sup>2</sup> C Vbus = 1.8 V Interface           | TCS34713FN      |
| TCS34715† | 0x29    | FN–6            | I <sup>2</sup> C Vbus = V <sub>DD</sub> Interface | TCS34715FN      |
| TCS34717  | 0x29    | FN–6            | I <sup>2</sup> C Vbus = 1.8 V Interface           | TCS34717FN      |

† Contact TAOS for availability.

### Absolute Maximum Ratings over operating free-air temperature range (unless otherwise noted)†

|  |                 |
|--|-----------------|
| Supply voltage, V <sub>DD</sub> (see Note 1) | 3.8 V           |
| Digital output voltage range, V <sub>O</sub> | –0.5 V to 3.8 V |
| Digital output current, I <sub>O</sub>       | –1 mA to 20 mA  |
| Storage temperature range, T <sub>stg</sub>  | –40°C to 85°C   |
| ESD tolerance, human body model              | 2000 V          |

† Stresses beyond those listed under “absolute maximum ratings” may cause permanent damage to the device. These are stress ratings only, and functional operation of the device at these or any other conditions beyond those indicated under “recommended operating conditions” is not implied. Exposure to absolute-maximum-rated conditions for extended periods may affect device reliability.

NOTE 1: All voltages are with respect to GND.

### Recommended Operating Conditions

|  | MIN | NOM | MAX | UNIT |
|--|-----|-----|-----|------|
| Supply voltage, V <sub>DD</sub>                | 2.7 | 3   | 3.3 | V    |
| Operating free-air temperature, T <sub>A</sub> | –30 |     | 70  | °C   |

### Operating Characteristics, V<sub>DD</sub> = 3 V, T<sub>A</sub> = 25°C (unless otherwise noted)

| PARAMETER         |                                     | TEST CONDITIONS                           | MIN                 | TYP | MAX                 | UNIT |
|-------------------|-------------------------------------|---|---------------------|-----|---------------------|------|
| I <sub>DD</sub>   | Supply current                      | Active                                    |                     | 235 | 330                 | μA   |
|                   |                                     | Wait mode                                 |                     | 65  |                     |      |
|                   |                                     | Sleep mode — no I <sup>2</sup> C activity |                     | 2.5 | 10                  |      |
| V <sub>OL</sub>   | INT, SDA output low voltage         | 3 mA sink current                         | 0                   |     | 0.4                 | V    |
|                   |                                     | 6 mA sink current                         | 0                   |     | 0.6                 |      |
| I <sub>LEAK</sub> | Leakage current, SDA, SCL, INT pins |   | –5                  |     | 5                   | μA   |
| I <sub>LEAK</sub> | Leakage current, LDR pin            |   | –1                  |     | +10                 | μA   |
| V <sub>IH</sub>   | SCL, SDA input high voltage         | TCS34711 & TCS34715                       | 0.7 V <sub>DD</sub> |     |                     | V    |
|                   |                                     | TCS34713 & TCS34717                       | 1.25                |     |                     |      |
| V <sub>IL</sub>   | SCL, SDA input low voltage          | TCS34711 & TCS34715                       |                     |     | 0.3 V <sub>DD</sub> | V    |
|                   |                                     | TCS34713 & TCS34717                       |                     |     | 0.54                |      |

# TCS3471

## COLOR LIGHT-TO-DIGITAL CONVERTER

TAOS115 – MARCH 2011

**Optical Characteristics,  $V_{DD} = 3\text{ V}$ ,  $T_A = 25^\circ\text{C}$ , GAIN = 16, ATIME = 0xF6 (unless otherwise noted) (see Note 1)**

| PARAMETER                  | TEST CONDITIONS                           | Red Channel |     |      | Green Channel |     |     | Blue Channel |     |     | Clear Channel |     |      | UNIT                                    |
|----------------------------|---|-------------|-----|------|---------------|-----|-----|--------------|-----|-----|---------------|-----|------|---|
|                            |   | MIN         | TYP | MAX  | MIN           | TYP | MAX | MIN          | TYP | MAX | MIN           | TYP | MAX  |   |
| Re Irradiance responsivity | $\lambda_D = 465\text{ nm}$<br>See Note 2 | 0%          |     | 15%  | 10%           |     | 42% | 65%          |     | 88% | 19.2          | 24  | 28.8 | (counts/<br>$\mu\text{W}/\text{cm}^2$ ) |
|                            | $\lambda_D = 525\text{ nm}$<br>See Note 3 | 8%          |     | 25%  | 60%           |     | 85% | 9%           |     | 35% | 22.4          | 28  | 33.6 |   |
|                            | $\lambda_D = 625\text{ nm}$<br>See Note 4 | 85%         |     | 110% | 0%            |     | 15% | 5%           |     | 25% | 27.2          | 34  | 40.8 |   |

- NOTES:
- The percentage shown represents the ratio of the respective red, green, or blue channel value to the clear channel value.
  - The 465 nm input irradiance is supplied by an InGaN light-emitting diode with the following characteristics: dominant wavelength  $\lambda_D = 465\text{ nm}$ , spectral halfwidth  $\Delta\lambda_{1/2} = 22\text{ nm}$ , and luminous efficacy = 75 lm/W.
  - The 525 nm input irradiance is supplied by an InGaN light-emitting diode with the following characteristics: dominant wavelength  $\lambda_D = 525\text{ nm}$ , spectral halfwidth  $\Delta\lambda_{1/2} = 35\text{ nm}$ , and luminous efficacy = 520 lm/W.
  - The 625 nm input irradiance is supplied by a AlInGaP light-emitting diode with the following characteristics: dominant wavelength  $\lambda_D = 625\text{ nm}$ , spectral halfwidth  $\Delta\lambda_{1/2} = 9\text{ nm}$ , and luminous efficacy = 155 lm/W.

**RGBC Characteristics,  $V_{DD} = 3\text{ V}$ ,  $T_A = 25^\circ\text{C}$ , AGAIN = 16, AEN = 1 (unless otherwise noted)**

| PARAMETER                                 | TEST CONDITIONS                                | MIN  | TYP | MAX   | UNIT   |
|---|--|------|-----|-------|--------|
| Dark ADC count value                      | $E_e = 0$ , AGAIN = 60X, ATIME = 0xD6 (100 ms) | 0    | 1   | 5     | counts |
| ADC integration time step size            | ATIME = 0xFF                                   | 2.27 | 2.4 | 2.56  | ms     |
| ADC number of integration steps           |  | 1    |     | 256   | steps  |
| ADC counts per step                       |  | 0    |     | 1024  | counts |
| ADC count value                           | ATIME = 0xC0 (153.6 ms)                        | 0    |     | 65535 | counts |
| Gain scaling, relative to 1X gain setting | 4X   | 3.8  | 4   | 4.2   | %      |
|   | 16X  | 15   | 16  | 16.8  |        |
|   | 60X  | 58   | 60  | 63    |        |

**Wait Characteristics,  $V_{DD} = 3\text{ V}$ ,  $T_A = 25^\circ\text{C}$ , Gain = 16, WEN = 1 (unless otherwise noted)**

| PARAMETER            | TEST CONDITIONS | CHANNEL | MIN  | TYP | MAX  | UNIT  |
|----------------------|-----------------|---------|------|-----|------|-------|
| Wait step size       | WTIME = 0xFF    |         | 2.27 | 2.4 | 2.56 | ms    |
| Wait number of steps |                 |         | 1    |     | 256  | steps |

AC Electrical Characteristics,  $V_{DD} = 3\text{ V}$ ,  $T_A = 25^\circ\text{C}$  (unless otherwise noted)

| PARAMETER†    | TEST CONDITIONS  | MIN | TYP | MAX | UNIT          |
|---------------|--|-----|-----|-----|---------------|
| $f_{(SCL)}$   | Clock frequency (I <sup>2</sup> C only)  | 0   |     | 400 | kHz           |
| $t_{(BUF)}$   | Bus free time between start and stop condition   | 1.3 |     |     | $\mu\text{s}$ |
| $t_{(HDSTA)}$ | Hold time after (repeated) start condition. After this period, the first clock is generated. | 0.6 |     |     | $\mu\text{s}$ |
| $t_{(SUSTA)}$ | Repeated start condition setup time  | 0.6 |     |     | $\mu\text{s}$ |
| $t_{(SUSTO)}$ | Stop condition setup time  | 0.6 |     |     | $\mu\text{s}$ |
| $t_{(HDDAT)}$ | Data hold time   | 0   |     |     | $\mu\text{s}$ |
| $t_{(SUDAT)}$ | Data setup time  | 100 |     |     | ns            |
| $t_{(LOW)}$   | SCL clock low period   | 1.3 |     |     | $\mu\text{s}$ |
| $t_{(HIGH)}$  | SCL clock high period  | 0.6 |     |     | $\mu\text{s}$ |
| $t_F$         | Clock/data fall time   |     |     | 300 | ns            |
| $t_R$         | Clock/data rise time   |     |     | 300 | ns            |
| $C_i$         | Input pin capacitance  |     |     | 10  | pF            |

† Specified by design and characterization; not production tested.

PARAMETER MEASUREMENT INFORMATION

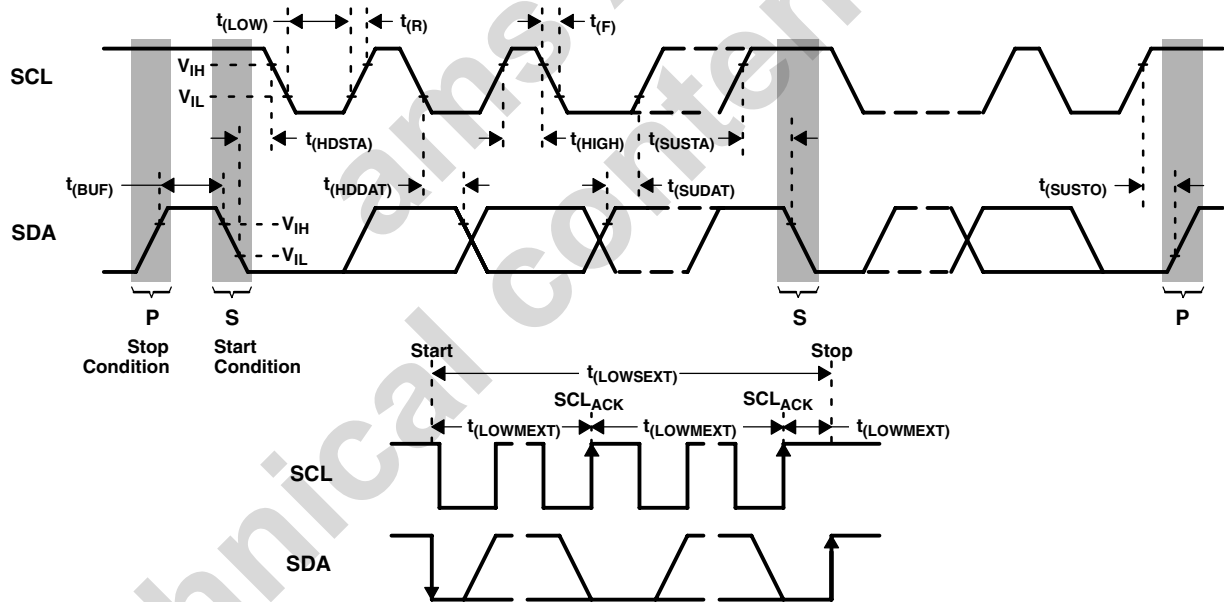

Figure 1. Timing Diagrams



TYPICAL CHARACTERISTICS

PHOTODIODE SPECTRAL RESPONSIVITY

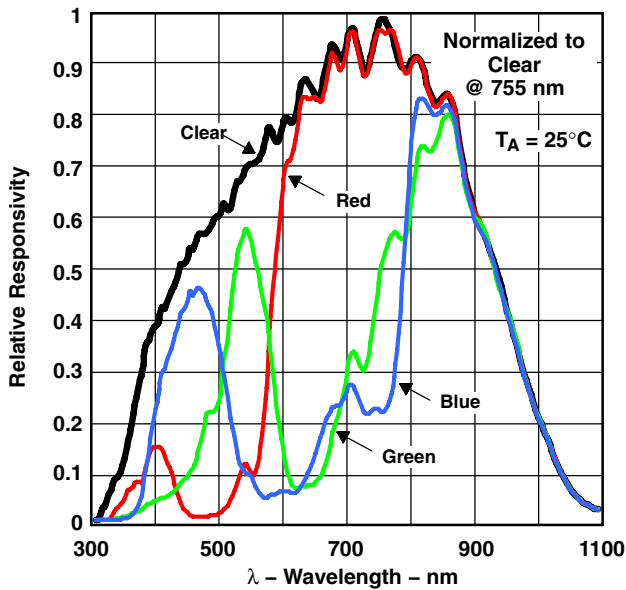

Figure 2

NORMALIZED  $I_{DD}$   
 vs.  
 $V_{DD}$  and TEMPERATURE

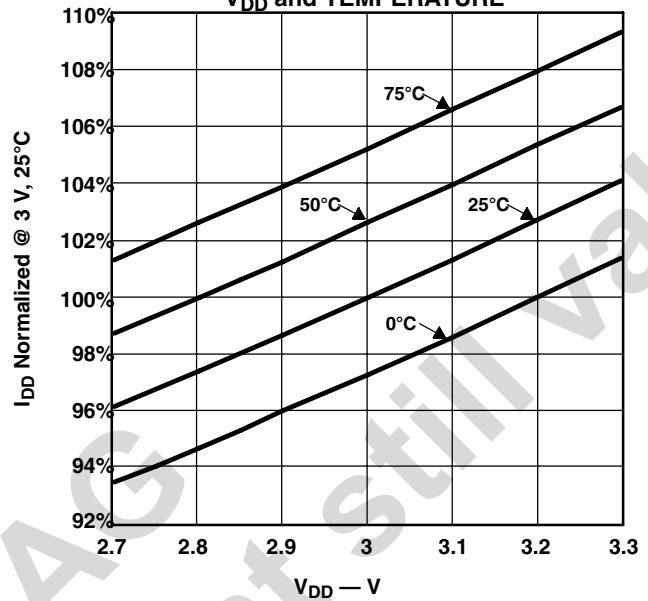

Figure 3

NORMALIZED RESPONSIVITY  
 vs.  
 ANGULAR DISPLACEMENT

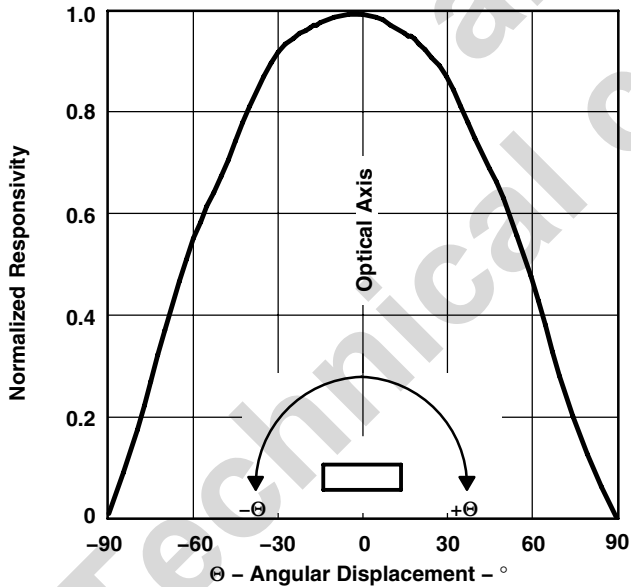

Figure 4

RESPONSIVITY TEMPERATURE  
 COEFFICIENT

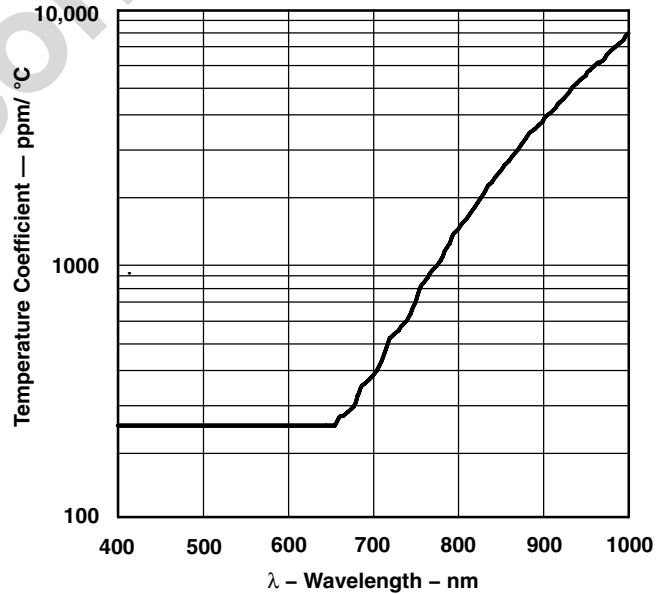

Figure 5

PRINCIPLES OF OPERATION

System State Machine

The TCS3471 provides control of RGBC and power management functionality through an internal state machine (Figure 6). After a power-on-reset, the device is in the sleep mode. As soon as the PON bit is set, the device will move to the start state. It will then continue through the Wait and RGBC states. If these states are enabled, the device will execute each function. If the PON bit is set to 0, the state machine will continue until all conversions are completed and then go into a low power sleep mode.

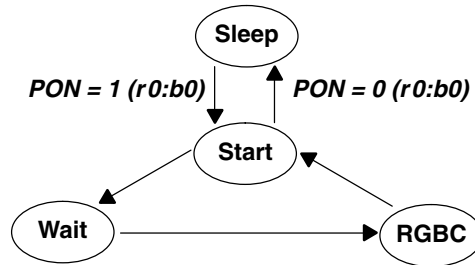

Figure 6. Simplified State Diagram

**NOTE:** In this document, the nomenclature uses the bit field name in italics followed by the register number and bit number to allow the user to easily identify the register and bit that controls the function. For example, the power on (PON) is in register 0, bit 0. This is represented as *PON (r0:b0)*.



# TCS3471 COLOR LIGHT-TO-DIGITAL CONVERTER

TAOS115 – MARCH 2011

## RGBC Operation

The RGBC engine contains RGBC gain control (AGAIN) and four integrating analog-to-digital converters (ADC) for the RGBC photodiodes. The RGBC integration time (ATIME) impacts both the resolution and the sensitivity of the RGBC reading. Integration of all four channels occurs simultaneously and upon completion of the conversion cycle, the results are transferred to the color data registers. This data is also referred to as channel *count*.

The transfers are double-buffered to ensure that invalid data is not read during the transfer. After the transfer, the device automatically moves to the next state in accordance with the configured state machine.

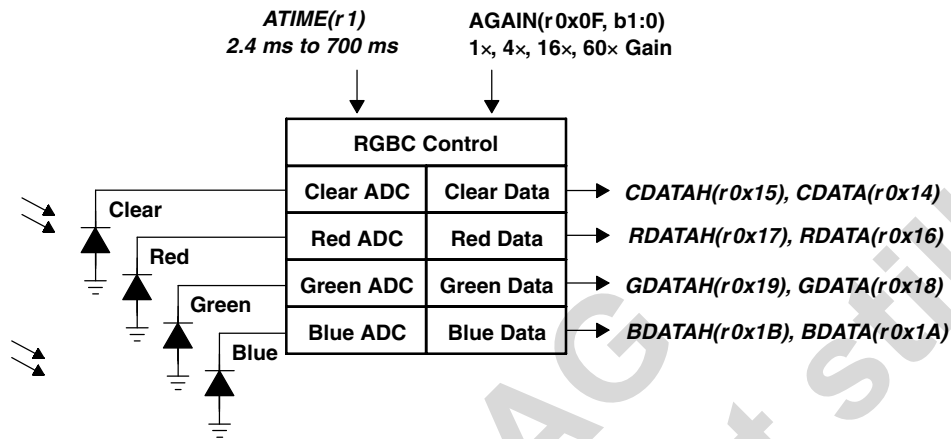

Figure 7. RGBC Operation

The registers for programming the integration and wait times are a 2's complement values. The actual time can be calculated as follows:

$$ATIME = 256 - \text{Integration Time} / 2.4 \text{ ms}$$

Inversely, the time can be calculated from the register value as follows:

$$\text{Integration Time} = 2.4 \text{ ms} \times (256 - ATIME)$$

For example, if a 100-ms integration time is needed, the device needs to be programmed to:

$$256 - (100 / 2.4) = 256 - 42 = 214 = 0xD6$$

Conversely, the programmed value of 0xC0 would correspond to:

$$(256 - 0xC0) \times 2.4 = 64 \times 2.4 = 154 \text{ ms.}$$

## Interrupts

The interrupt feature simplifies and improves system efficiency by eliminating the need to poll the sensor for light intensity values outside of a user-defined range. While the interrupt function is always enabled and its status is available in the status register (0x13), the output of the interrupt state can be enabled using the RGBC interrupt enable (AIEN) field in the enable register (0x00).

Two 16-bit interrupt threshold registers allow the user to set limits below and above a desired light level range. An interrupt can be generated when the RGBC Clear data (CDATA) falls outside of the desired light level range, as determined by the values in the RGBC interrupt low threshold registers (AILTx) and RGBC interrupt high threshold registers (AIHTx). It is important to note that the low threshold value must be less than the high threshold value for proper operation.

To further control when an interrupt occurs, the device provides a persistence filter. The persistence filter allows the user to specify the number of consecutive out-of-range RGBC occurrences before an interrupt is generated. The persistence register (0x0C) allows the user to set the persistence (APERS) value. See the persistence register for details on the persistence filter values. Once the persistence filter generates an interrupt, it will continue until a special function interrupt clear command is received (see command register).

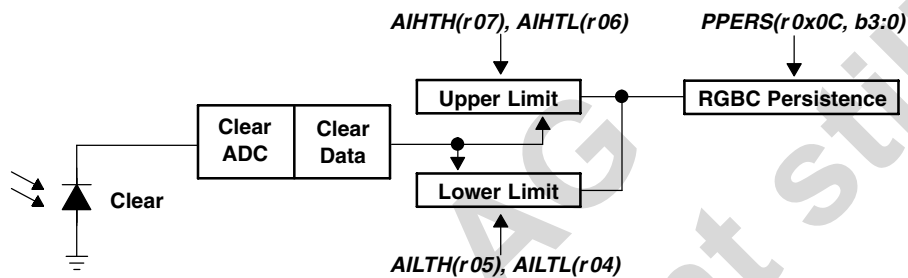

Figure 8. Programmable Interrupt

## State Diagram

Figure 9 shows a more detailed flow for the state machine. The device starts in the sleep mode. The PON bit is written to enable the device. A 2.4-ms delay will occur before entering the start state. If the WEN bit is set, the state machine will cycle through the wait state. If the WLONG bit is set, the wait cycles are extended by 12x over normal operation. When the wait counter terminates, the state machine will step to the RGBC state.

The AEN should always be set. In this case, a minimum of 1 integration time step should be programmed. The RGBC state machine will continue until it reaches the terminal count, at which point the data will be latched in the RGBC register and the interrupt set, if enabled.

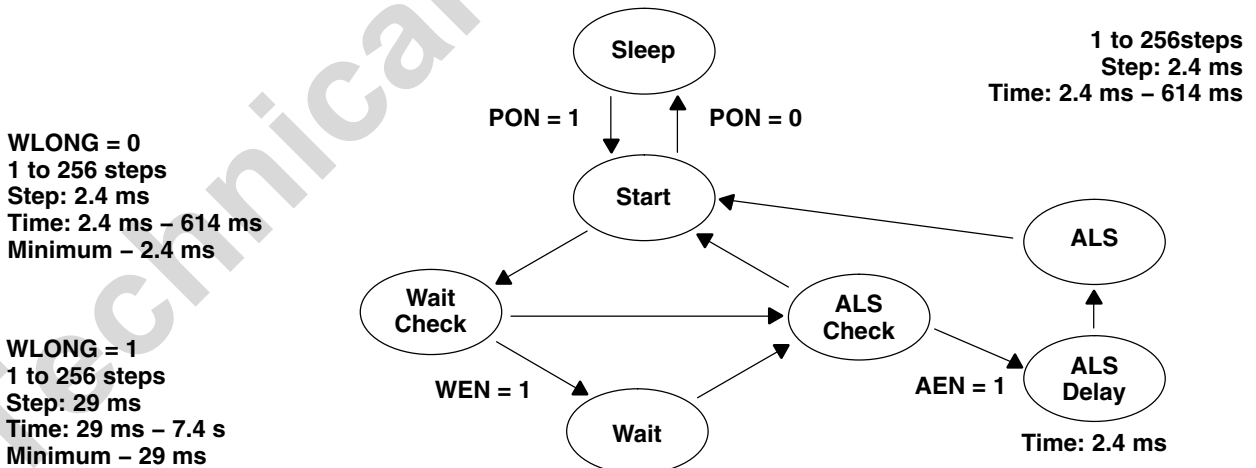

Figure 9. Expanded State Diagram

# TCS3471

## COLOR LIGHT-TO-DIGITAL CONVERTER

TAOS115 – MARCH 2011

### I<sup>2</sup>C Protocol

Interface and control are accomplished through an I<sup>2</sup>C serial compatible interface (standard or fast mode) to a set of registers that provide access to device control functions and output data. The devices support the 7-bit I<sup>2</sup>C addressing protocol.

The I<sup>2</sup>C standard provides for three types of bus transaction: read, write, and a combined protocol (Figure 10). During a write operation, the first byte written is a command byte followed by data. In a combined protocol, the first byte written is the command byte followed by reading a series of bytes. If a read command is issued, the register address from the previous command will be used for data access. Likewise, if the MSB of the command is not set, the device will write a series of bytes at the address stored in the last valid command with a register address. The command byte contains either control information or a 5-bit register address. The control commands can also be used to clear interrupts.

The I<sup>2</sup>C bus protocol was developed by Philips (now NXP). For a complete description of the I<sup>2</sup>C protocol, please review the NXP I<sup>2</sup>C design specification at <http://www.i2c-bus.org/references/>.

- A** Acknowledge (0)
- N** Not Acknowledged (1)
- P** Stop Condition
- R** Read (1)
- S** Start Condition
- Sr** Repeated Start Condition
- W** Write (0)
- ...** Continuation of protocol
- Master-to-Slave
- Slave-to-Master

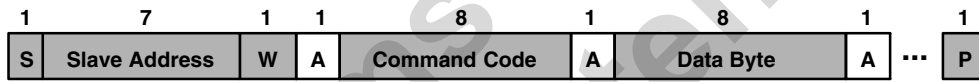

I<sup>2</sup>C Write Protocol



I<sup>2</sup>C Read Protocol

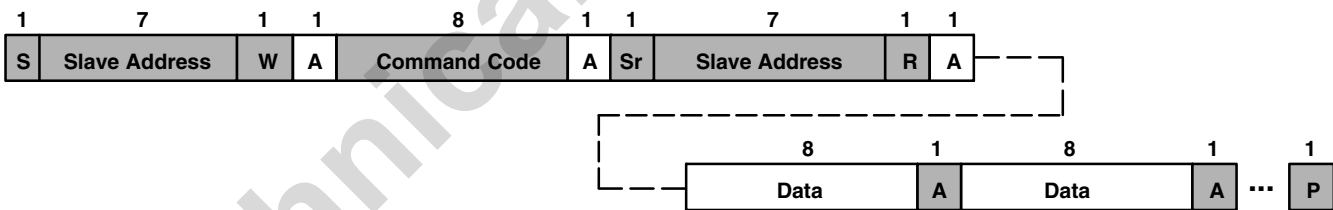

I<sup>2</sup>C Read Protocol — Combined Format

Figure 10. I<sup>2</sup>C Protocols

## Register Set

The TCS3471 is controlled and monitored by data registers and a command register accessed through the serial interface. These registers provide for a variety of control functions and can be read to determine results of the ADC conversions. The register set is summarized in Table 1.

**Table 1. Register Address**

| ADDRESS | REGISTER NAME | R/W | REGISTER FUNCTION                       | RESET VALUE |
|---------|---------------|-----|---|-------------|
| --      | COMMAND       | W   | Specifies register address              | 0x00        |
| 0x00    | ENABLE        | R/W | Enables states and interrupts           | 0x00        |
| 0x01    | ATIME         | R/W | RGBC ADC time                           | 0xFF        |
| 0x03    | WTIME         | R/W | Wait time                               | 0xFF        |
| 0x04    | AILTL         | R/W | RGBC interrupt low threshold low byte   | 0x00        |
| 0x05    | AILTH         | R/W | RGBC interrupt low threshold high byte  | 0x00        |
| 0x06    | AIHTL         | R/W | RGBC interrupt high threshold low byte  | 0x00        |
| 0x07    | AIHTH         | R/W | RGBC interrupt high threshold high byte | 0x00        |
| 0x0C    | PERS          | R/W | Interrupt persistence filters           | 0x00        |
| 0x0D    | CONFIG        | R/W | Configuration                           | 0x00        |
| 0x0F    | CONTROL       | R/W | Gain control register                   | 0x00        |
| 0x12    | ID            | R   | Device ID                               | ID          |
| 0x13    | STATUS        | R   | Device status                           | 0x00        |
| 0x14    | CDATA         | R   | Clear ADC low data register             | 0x00        |
| 0x15    | CDATAH        | R   | Clear ADC high data register            | 0x00        |
| 0x16    | RDATA         | R   | Red ADC low data register               | 0x00        |
| 0x17    | RDATAH        | R   | Red ADC high data register              | 0x00        |
| 0x18    | GDATA         | R   | Green ADC low data register             | 0x00        |
| 0x19    | GDATAH        | R   | Green ADC high data register            | 0x00        |
| 0x1A    | BDATA         | R   | Blue ADC low data register              | 0x00        |
| 0x1B    | BDATAH        | R   | Blue ADC high data register             | 0x00        |

The mechanics of accessing a specific register depends on the specific protocol used. See the section on I<sup>2</sup>C protocols on the previous pages. In general, the COMMAND register is written first to specify the specific control/status register for the following read/write operations.

# TCS3471

## COLOR LIGHT-TO-DIGITAL CONVERTER

TAOS115 – MARCH 2011

### Command Register

The command registers specifies the address of the target register for future write and read operations.

**Table 2. Command Register**

|         |         | 7  | 6  | 5 | 4 | 3 | 2 | 1   | 0 |    |
|---------|---------|--|--|---|---|---|---|-----|---|----|
| COMMAND | COMMAND | TYPE   |  |   |   |   |   | ADD |   | -- |
| FIELD   | BITS    | DESCRIPTION  |  |   |   |   |   |     |   |    |
| COMMAND | 7       | Select Command Register. Must write as 1 when addressing COMMAND register.   |  |   |   |   |   |     |   |    |
| TYPE    | 6:5     | Selects type of transaction to follow in subsequent data transfers:  |  |   |   |   |   |     |   |    |
|         |         | <b>FIELD VALUE</b>   | <b>INTEGRATION TIME</b>                  |   |   |   |   |     |   |    |
|         |         | 00   | Repeated byte protocol transaction       |   |   |   |   |     |   |    |
|         |         | 01   | Auto-increment protocol transaction      |   |   |   |   |     |   |    |
|         |         | 10   | Reserved — Do not use                    |   |   |   |   |     |   |    |
|         |         | 11   | Special function — See description below |   |   |   |   |     |   |    |
|         |         | Byte protocol will repeatedly read the same register with each data access.<br>Block protocol will provide auto-increment function to read successive bytes.   |  |   |   |   |   |     |   |    |
| ADD     | 4:0     | Address field/special function field. Depending on the transaction type, see above, this field either specifies a special function command or selects the specific control-status-register for following write and read transactions. The field values listed below apply only to special function commands: |  |   |   |   |   |     |   |    |
|         |         | <b>FIELD VALUE</b>   | <b>READ VALUE</b>                        |   |   |   |   |     |   |    |
|         |         | 00000  | Normal — no action                       |   |   |   |   |     |   |    |
|         |         | 00110  | RGBC interrupt clear                     |   |   |   |   |     |   |    |
|         |         | other  | Reserved — Do not write                  |   |   |   |   |     |   |    |
|         |         | RGBC Interrupt Clear. Clears any pending RGBC interrupt. This special function is self clearing.   |  |   |   |   |   |     |   |    |

### Enable Register (0x00)

The Enable register is used primarily to power the TCS3471 device on and off, and enable functions and interrupts as shown in Table 3.

**Table 3. Enable Register**

|               |          |   |   |      |     |          |     |     |                         |
|---------------|----------|---|---|------|-----|----------|-----|-----|-------------------------|
|               | 7        | 6 | 5 | 4    | 3   | 2        | 1   | 0   |                         |
| <b>ENABLE</b> | Reserved |   |   | AIEN | WEN | Reserved | AEN | PON | <b>Address<br/>0x00</b> |

| FIELD            | BITS | DESCRIPTION   |
|------------------|------|---|
| Reserved         | 7:5  | Reserved. Write as 0.   |
| AIEN             | 4    | RGBC interrupt enable. When asserted, permits RGBC interrupts to be generated.  |
| WEN              | 3    | Wait enable. This bit activates the wait feature. Writing a 1 activates the wait timer. Writing a 0 disables the wait timer.  |
| Reserved         | 2    | Reserved. Write as 0.   |
| AEN              | 1    | RGBC enable. This bit activates the two-channel ADC. Writing a 1 activates the RGBC. Writing a 0 disables the RGBC.   |
| PON <sup>1</sup> | 0    | Power ON. This bit activates the internal oscillator to permit the timers and ADC channels to operate. Writing a 1 activates the oscillator. Writing a 0 disables the oscillator. During reads and writes over the I <sup>2</sup> C interface, this bit is temporarily overridden and the oscillator is enabled, independent of the state of PON. |

NOTE 1: A minimum interval of 2.4 ms must pass after PON is asserted before an RGBC can be initiated.

### RGBC Timing Register (0x01)

The RGBC timing register controls the internal integration time of the RGBC clear and IR channel ADCs in 2.4-ms increments. Max RGBC Count = (256 – ATIME) × 1024 up to a maximum of 65535.

**Table 4. RGBC Timing Register**

| FIELD | BITS | DESCRIPTION |              |        |           |
|-------|------|-------------|--------------|--------|-----------|
|       |      | VALUE       | INTEG_CYCLES | TIME   | MAX COUNT |
| ATIME | 7:0  | 0xFF        | 1            | 2.4 ms | 1024      |
|       |      | 0xF6        | 10           | 24 ms  | 10240     |
|       |      | 0xD5        | 42           | 101 ms | 43008     |
|       |      | 0xC0        | 64           | 154 ms | 65535     |
|       |      | 0x00        | 256          | 700 ms | 65535     |

### Wait Time Register (0x03)

Wait time is set 2.4 ms increments unless the WLONG bit is asserted, in which case the wait times are 12× longer. WTIME is programmed as a 2's complement number.

**Table 5. Wait Time Register**

| FIELD | BITS | DESCRIPTION    |           |                  |                  |
|-------|------|----------------|-----------|------------------|------------------|
|       |      | REGISTER VALUE | WAIT TIME | TIME (WLONG = 0) | TIME (WLONG = 1) |
| WTIME | 7:0  | 0xFF           | 1         | 2.4 ms           | 0.029 sec        |
|       |      | 0xAB           | 85        | 204 ms           | 2.45 sec         |
|       |      | 0x00           | 256       | 614 ms           | 7.4 sec          |

# TCS3471 COLOR LIGHT-TO-DIGITAL CONVERTER

TAOS115 – MARCH 2011

## RGBC Interrupt Threshold Registers (0x04 – 0x07)

The RGBC interrupt threshold registers provides the values to be used as the high and low trigger points for the comparison function for interrupt generation. If the value generated by the clear channel crosses below the lower threshold specified, or above the higher threshold, an interrupt is asserted on the interrupt pin.

**Table 6. RGBC Interrupt Threshold Registers**

| REGISTER | ADDRESS | BITS | DESCRIPTION                                  |
|----------|---------|------|--|
| AILTL    | 0x04    | 7:0  | RGBC clear channel low threshold lower byte  |
| AILTH    | 0x05    | 7:0  | RGBC clear channel low threshold upper byte  |
| AIHTL    | 0x06    | 7:0  | RGBC clear channel high threshold lower byte |
| AIHTH    | 0x07    | 7:0  | RGBC clear channel high threshold upper byte |

## Persistence Register (0x0C)

The persistence register controls the filtering interrupt capabilities of the device. Configurable filtering is provided to allow interrupts to be generated after each integration cycle or if the integration has produced a result that is outside of the values specified by the threshold register for some specified amount of time.

**Table 7. Persistence Register**

|          |      | 7  | 6       | 5  | 4 | 3     | 2 | 1 | 0 | Address<br>0x0C |
|----------|------|--|---------|--|---|-------|---|---|---|-----------------|
| PERS     |      | Reserved   |         |  |   | APERS |   |   |   |                 |
| FIELD    | BITS | DESCRIPTION  |         |  |   |       |   |   |   |                 |
| Reserved | 7:4  | Reserved   |         |  |   |       |   |   |   |                 |
| APERS    | 3:0  | Interrupt persistence. Controls rate of interrupt to the host processor. |         |  |   |       |   |   |   |                 |
|          |      | FIELD VALUE  | MEANING | INTERRUPT PERSISTENCE FUNCTION                   |   |       |   |   |   |                 |
|          |      | 0000   | Every   | Every RGBC cycle generates an interrupt          |   |       |   |   |   |                 |
|          |      | 0001   | 1       | 1 clear channel value outside of threshold range |   |       |   |   |   |                 |
|          |      | 0010   | 2       | 2 clear channel consecutive values out of range  |   |       |   |   |   |                 |
|          |      | 0011   | 3       | 3 clear channel consecutive values out of range  |   |       |   |   |   |                 |
|          |      | 0100   | 5       | 5 clear channel consecutive values out of range  |   |       |   |   |   |                 |
|          |      | 0101   | 10      | 10 clear channel consecutive values out of range |   |       |   |   |   |                 |
|          |      | 0110   | 15      | 15 clear channel consecutive values out of range |   |       |   |   |   |                 |
|          |      | 0111   | 20      | 20 clear channel consecutive values out of range |   |       |   |   |   |                 |
|          |      | 1000   | 25      | 25 clear channel consecutive values out of range |   |       |   |   |   |                 |
|          |      | 1001   | 30      | 30 clear channel consecutive values out of range |   |       |   |   |   |                 |
|          |      | 1010   | 35      | 35 clear channel consecutive values out of range |   |       |   |   |   |                 |
|          |      | 1011   | 40      | 40 clear channel consecutive values out of range |   |       |   |   |   |                 |
|          |      | 1100   | 45      | 45 clear channel consecutive values out of range |   |       |   |   |   |                 |
| 1101     | 50   | 50 clear channel consecutive values out of range                         |         |  |   |       |   |   |   |                 |
| 1110     | 55   | 55 clear channel consecutive values out of range                         |         |  |   |       |   |   |   |                 |
| 1111     | 60   | 60 clear channel consecutive values out of range                         |         |  |   |       |   |   |   |                 |

### Configuration Register (0x0D)

The configuration register sets the wait long time.

**Table 8. Configuration Register**

|        |          |   |   |   |   |   |       |          |                 |
|--------|----------|---|---|---|---|---|-------|----------|-----------------|
|        | 7        | 6 | 5 | 4 | 3 | 2 | 1     | 0        |                 |
| CONFIG | Reserved |   |   |   |   |   | WLONG | Reserved | Address<br>0x0D |

| FIELD    | BITS | DESCRIPTION   |
|----------|------|---|
| Reserved | 7:2  | Reserved. Write as 0.   |
| WLONG    | 1    | Wait Long. When asserted, the wait cycles are increased by a factor 12× from that programmed in the WTIME register. |
| Reserved | 0    | Reserved. Write as 0.   |

### Control Register (0x0F)

The Control register provides eight bits of miscellaneous control to the analog block. These bits typically control functions such as gain settings and/or diode selection.

**Table 9. Control Register**

|         |          |   |   |   |   |   |       |                 |  |
|---------|----------|---|---|---|---|---|-------|-----------------|--|
|         | 7        | 6 | 5 | 4 | 3 | 2 | 1     | 0               |  |
| CONTROL | Reserved |   |   |   |   |   | AGAIN | Address<br>0x0F |  |

| FIELD    | BITS | DESCRIPTION               |                        |
|----------|------|---------------------------|------------------------|
| Reserved | 7:2  | Reserved. Write bits as 0 |                        |
| AGAIN    | 1:0  | RGBC Gain Control.        |                        |
|          |      | <b>FIELD VALUE</b>        | <b>RGBC GAIN VALUE</b> |
|          |      | 00                        | 1× gain                |
|          |      | 01                        | 4× gain                |
|          |      | 10                        | 16× gain               |
|          |      | 11                        | 60× gain               |

### ID Register (0x12)

The ID Register provides the value for the part number. The ID register is a read-only register.

**Table 10. ID Register**

|    |    |   |   |   |   |   |   |   |                 |
|----|----|---|---|---|---|---|---|---|-----------------|
|    | 7  | 6 | 5 | 4 | 3 | 2 | 1 | 0 |                 |
| ID | ID |   |   |   |   |   |   |   | Address<br>0x12 |

| FIELD | BITS | DESCRIPTION                |                            |
|-------|------|----------------------------|----------------------------|
| ID    | 7:0  | Part number identification | 0x14 = TCS34711 & TCS34715 |
|       |      |                            | 0x1D = TCS34713 & TCS34717 |



# TCS3471

## COLOR LIGHT-TO-DIGITAL CONVERTER

TAOS115 – MARCH 2011

### Status Register (0x13)

The Status Register provides the internal status of the device. This register is read only.

**Table 11. Status Register**

|               |          |   |   |      |          |   |   |        |                         |
|---------------|----------|---|---|------|----------|---|---|--------|-------------------------|
|               | 7        | 6 | 5 | 4    | 3        | 2 | 1 | 0      |                         |
| <b>STATUS</b> | Reserved |   |   | AINT | Reserved |   |   | AVALID | <b>Address<br/>0x13</b> |

| FIELD    | BIT | DESCRIPTION   |
|----------|-----|---|
| Reserved | 7:5 | Reserved.   |
| AINT     | 4   | RGBC clear channel Interrupt.   |
| Reserved | 3:1 | Reserved.   |
| AVALID   | 0   | RGBC Valid. Indicates that the RGBC channels have completed an integration cycle. |

### RGBC Channel Data Registers (0x14 – 0x1B)

Clear, red, green, and blue data is stored as 16-bit values. To ensure the data is read correctly, a two-byte read I<sup>2</sup>C transaction should be used with a read word protocol bit set in the command register. With this operation, when the lower byte register is read, the upper eight bits are stored into a shadow register, which is read by a subsequent read to the upper byte. The upper register will read the correct value even if additional ADC integration cycles end between the reading of the lower and upper registers.

**Table 12. ADC Channel Data Registers**

| REGISTER | ADDRESS | BITS | DESCRIPTION          |
|----------|---------|------|----------------------|
| CDATA    | 0x14    | 7:0  | Clear data low byte  |
| CDATAH   | 0x15    | 7:0  | Clear data high byte |
| RDATA    | 0x16    | 7:0  | Red data low byte    |
| RDATAH   | 0x17    | 7:0  | Red data high byte   |
| GDATA    | 0x18    | 7:0  | Green data low byte  |
| GDATAH   | 0x19    | 7:0  | Green data high byte |
| BDATA    | 0x1A    | 7:0  | Blue data low byte   |
| BDATAH   | 0x1B    | 7:0  | Blue data high byte  |

APPLICATION INFORMATION: HARDWARE

Typical Hardware Application

A typical hardware application circuit is shown in Figure 11. A 1- $\mu$ F low-ESR decoupling capacitor should be placed as close as possible to the  $V_{DD}$  pin.

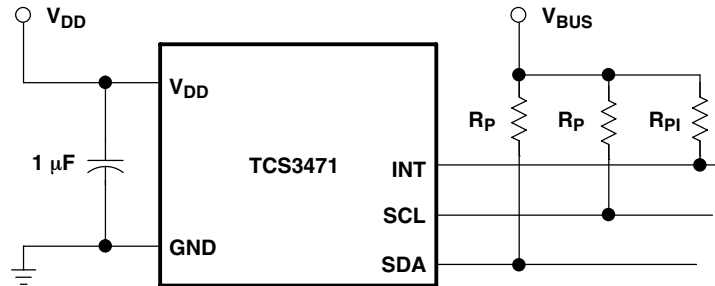

Figure 11. Typical Application Hardware Circuit

$V_{BUS}$  in Figure 11 refers to the I<sup>2</sup>C bus voltage, which is either  $V_{DD}$  or 1.8 V. Be sure to apply the specified I<sup>2</sup>C bus voltage shown in the Available Options table for the specific device being used.

The I<sup>2</sup>C signals and the Interrupt are open-drain outputs and require pull-up resistors. The pull-up resistor ( $R_P$ ) value is a function of the I<sup>2</sup>C bus speed, the I<sup>2</sup>C bus voltage, and the capacitive load. The TAOS EVM running at 400 kbps, uses 1.5-k $\Omega$  resistors. A 10-k $\Omega$  pull-up resistor ( $R_{PI}$ ) can be used for the interrupt line.

PCB Pad Layout

Suggested PCB pad layout guidelines for the Dual Flat No-Lead (FN) surface mount package are shown in Figure 12.

Note: Pads can be extended further if hand soldering is needed.

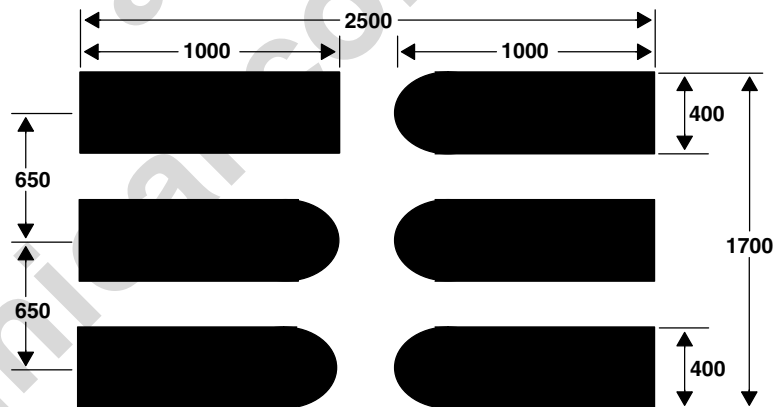

NOTES: A. All linear dimensions are in micrometers.  
 B. This drawing is subject to change without notice.

Figure 12. Suggested FN Package PCB Layout

# TCS3471 COLOR LIGHT-TO-DIGITAL CONVERTER

TAOS115 – MARCH 2011

## MECHANICAL DATA

PACKAGE FN

Dual Flat No-Lead

TOP VIEW

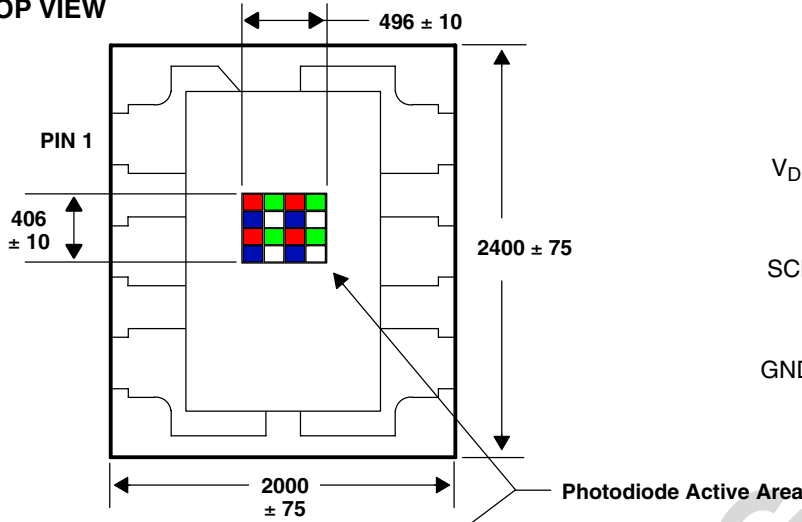

PIN OUT  
TOP VIEW

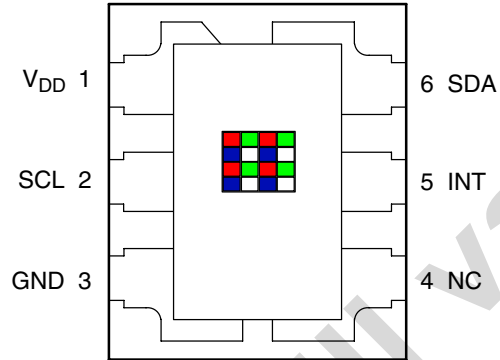

END VIEW

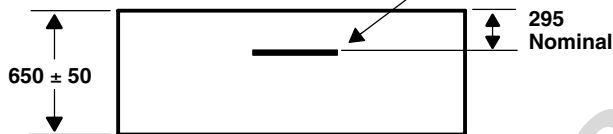

SIDE VIEW

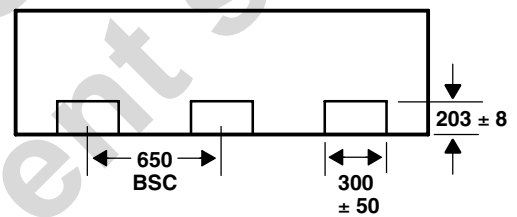

BOTTOM VIEW

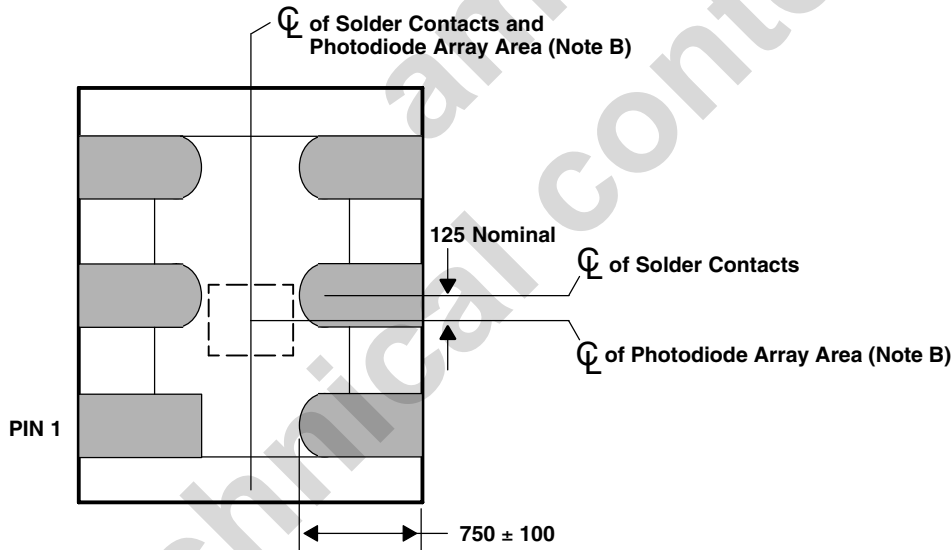

Lead Free

- NOTES: A. All linear dimensions are in micrometers.  
 B. The die is centered within the package within a tolerance of ± 75 μm.  
 C. Package top surface is molded with an electrically nonconductive clear plastic compound having an index of refraction of 1.55.  
 D. Contact finish is copper alloy A194 with pre-plated NiPdAu lead finish.  
 E. This package contains no lead (Pb).  
 F. This drawing is subject to change without notice.

Figure 13. Package FN — Dual Flat No-Lead Packaging Configuration

MECHANICAL DATA

TOP VIEW

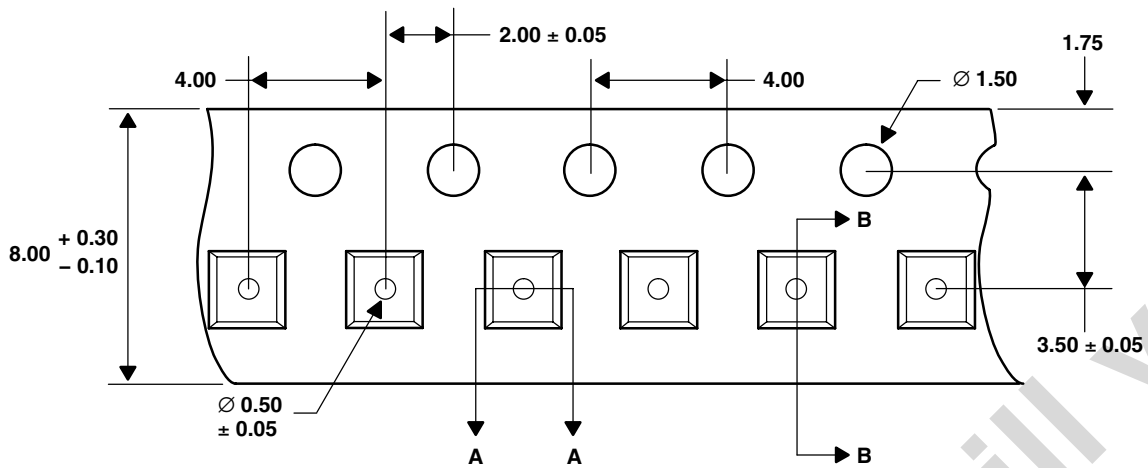

DETAIL A

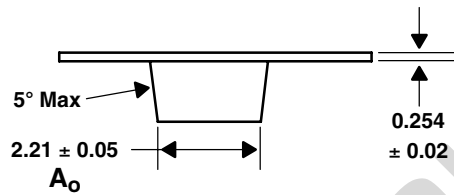

DETAIL B

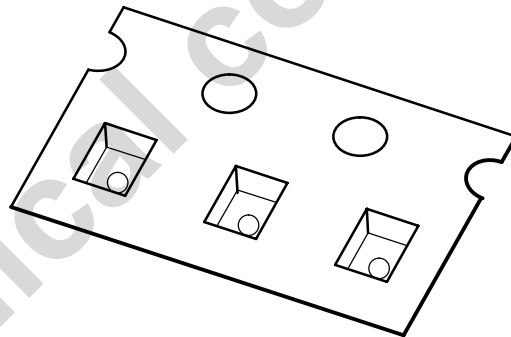
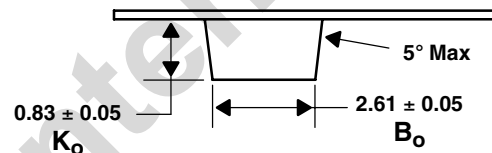

- NOTES: A. All linear dimensions are in millimeters. Dimension tolerance is  $\pm 0.10$  mm unless otherwise noted.  
 B. The dimensions on this drawing are for illustrative purposes only. Dimensions of an actual carrier may vary slightly.  
 C. Symbols on drawing  $A_o$ ,  $B_o$ , and  $K_o$  are defined in ANSI EIA Standard 481-B 2001.  
 D. Each reel is 178 millimeters in diameter and contains 3500 parts.  
 E. TAOS packaging tape and reel conform to the requirements of EIA Standard 481-B.  
 F. In accordance with EIA standard, device pin 1 is located next to the sprocket holes in the tape.  
 G. This drawing is subject to change without notice.

Figure 14. Package FN Carrier Tape

# TCS3471 COLOR LIGHT-TO-DIGITAL CONVERTER

TAOS115 – MARCH 2011

## MANUFACTURING INFORMATION

The FN package has been tested and has demonstrated an ability to be reflow soldered to a PCB substrate.

The solder reflow profile describes the expected maximum heat exposure of components during the solder reflow process of product on a PCB. Temperature is measured on top of component. The components should be limited to a maximum of three passes through this solder reflow profile.

**Table 13. Solder Reflow Profile**

| PARAMETER                                     | REFERENCE  | TCS3471        |
|---|------------|----------------|
| Average temperature gradient in preheating    |            | 2.5°C/sec      |
| Soak time                                     | $t_{soak}$ | 2 to 3 minutes |
| Time above 217°C (T1)                         | $t_1$      | Max 60 sec     |
| Time above 230°C (T2)                         | $t_2$      | Max 50 sec     |
| Time above $T_{peak} - 10^\circ\text{C}$ (T3) | $t_3$      | Max 10 sec     |
| Peak temperature in reflow                    | $T_{peak}$ | 260°C          |
| Temperature gradient in cooling               |            | Max -5°C/sec   |

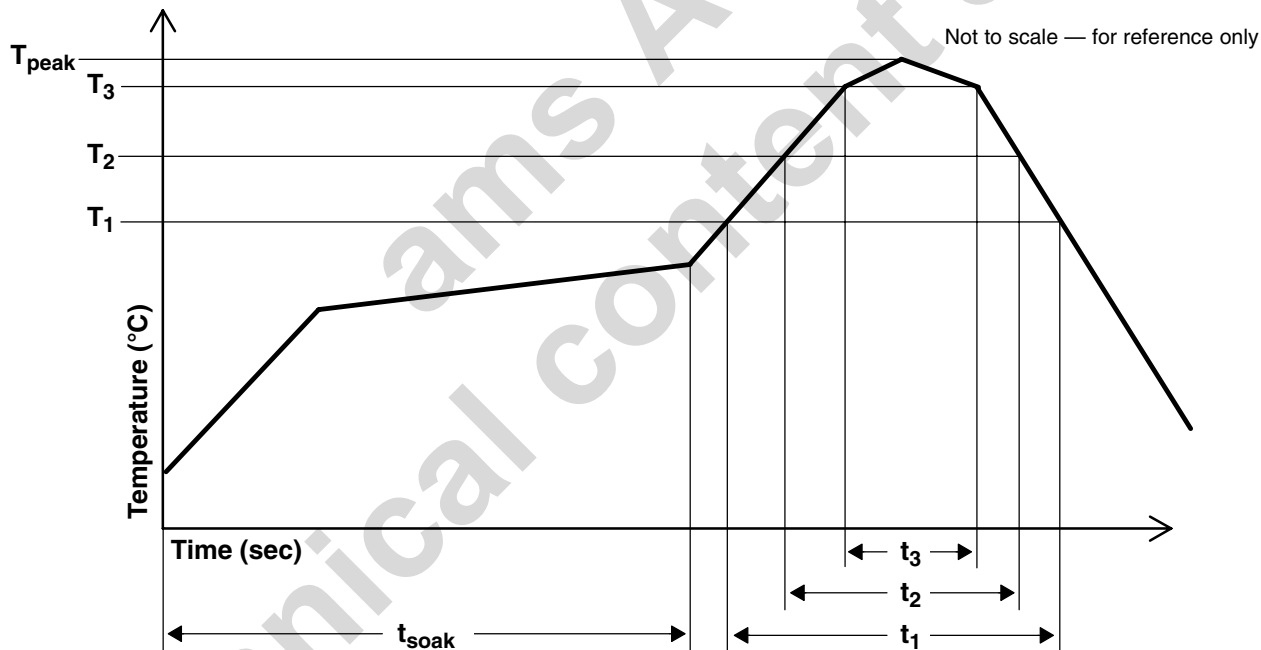

**Figure 15. Solder Reflow Profile Graph**

---

**MANUFACTURING INFORMATION**

**Moisture Sensitivity**

Optical characteristics of the device can be adversely affected during the soldering process by the release and vaporization of moisture that has been previously absorbed into the package. To ensure the package contains the smallest amount of absorbed moisture possible, each device is dry-baked prior to being packed for shipping. Devices are packed in a sealed aluminized envelope called a moisture barrier bag with silica gel to protect them from ambient moisture during shipping, handling, and storage before use.

The FN package has been assigned a moisture sensitivity level of MSL 3 and the devices should be stored under the following conditions:

|                   |   |
|-------------------|---|
| Temperature Range | 5°C to 50°C   |
| Relative Humidity | 60% maximum   |
| Total Time        | 12 months from the date code on the aluminized envelope — if unopened |
| Opened Time       | 168 hours or fewer  |

Rebaking will be required if the devices have been stored unopened for more than 12 months or if the aluminized envelope has been open for more than 168 hours. If rebaking is required, it should be done at 50°C for 12 hours.

# TCS3471

## COLOR LIGHT-TO-DIGITAL CONVERTER

TAOS115 – MARCH 2011

---

**PRODUCTION DATA** — information in this document is current at publication date. Products conform to specifications in accordance with the terms of Texas Advanced Optoelectronic Solutions, Inc. standard warranty. Production processing does not necessarily include testing of all parameters.

### ***LEAD-FREE (Pb-FREE) and GREEN STATEMENT***

**Pb-Free (RoHS)** TAOS' terms *Lead-Free* or *Pb-Free* mean semiconductor products that are compatible with the current RoHS requirements for all 6 substances, including the requirement that lead not exceed 0.1% by weight in homogeneous materials. Where designed to be soldered at high temperatures, TAOS Pb-Free products are suitable for use in specified lead-free processes.

**Green (RoHS & no Sb/Br)** TAOS defines *Green* to mean Pb-Free (RoHS compatible), and free of Bromine (Br) and Antimony (Sb) based flame retardants (Br or Sb do not exceed 0.1% by weight in homogeneous material).

**Important Information and Disclaimer** The information provided in this statement represents TAOS' knowledge and belief as of the date that it is provided. TAOS bases its knowledge and belief on information provided by third parties, and makes no representation or warranty as to the accuracy of such information. Efforts are underway to better integrate information from third parties. TAOS has taken and continues to take reasonable steps to provide representative and accurate information but may not have conducted destructive testing or chemical analysis on incoming materials and chemicals. TAOS and TAOS suppliers consider certain information to be proprietary, and thus CAS numbers and other limited information may not be available for release.

### **NOTICE**

Texas Advanced Optoelectronic Solutions, Inc. (TAOS) reserves the right to make changes to the products contained in this document to improve performance or for any other purpose, or to discontinue them without notice. Customers are advised to contact TAOS to obtain the latest product information before placing orders or designing TAOS products into systems.

TAOS assumes no responsibility for the use of any products or circuits described in this document or customer product design, conveys no license, either expressed or implied, under any patent or other right, and makes no representation that the circuits are free of patent infringement. TAOS further makes no claim as to the suitability of its products for any particular purpose, nor does TAOS assume any liability arising out of the use of any product or circuit, and specifically disclaims any and all liability, including without limitation consequential or incidental damages.

TEXAS ADVANCED OPTOELECTRONIC SOLUTIONS, INC. PRODUCTS ARE NOT DESIGNED OR INTENDED FOR USE IN CRITICAL APPLICATIONS IN WHICH THE FAILURE OR MALFUNCTION OF THE TAOS PRODUCT MAY RESULT IN PERSONAL INJURY OR DEATH. USE OF TAOS PRODUCTS IN LIFE SUPPORT SYSTEMS IS EXPRESSLY UNAUTHORIZED AND ANY SUCH USE BY A CUSTOMER IS COMPLETELY AT THE CUSTOMER'S RISK.

LUMENOLOGY, TAOS, the TAOS logo, and Texas Advanced Optoelectronic Solutions are registered trademarks of Texas Advanced Optoelectronic Solutions Incorporated.