

## PHOTO INTERRUPTER (Transmission)

### General Description

The FI-206L is Photo-Interrupter high-performance standard type. combines high-output GaAs IRED with high sensitive Photo-transistor.

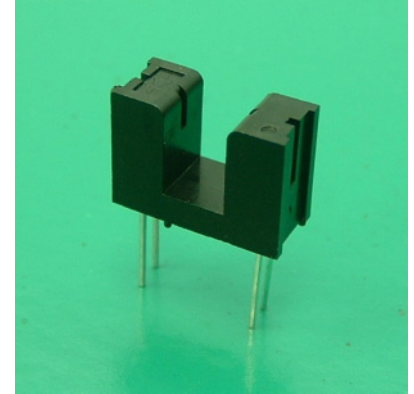

### Features

- PWB direct mount type
- GAP:5.0mm
- With the installation positioning boss
- Low cost
- Meet RoHS

### Applications

- Facsimiles
- Printers
- Scanner
- Copies
- Amusement machines

### MAXIMUM RATINGS

(Ta=25°C)

Item		Symbol	Rating	Unit
Input	Power dissipation	PD	100	mW
	Forward current	IF	60	mA
	Reverse voltage	VR	5	V
	Pulse forward current *1	IFP	1	A
Output	Collector power dissipation	PC	100	mW
	Collector current	IC	40	mA
	Collector-Emitter voltage	VCEO	30	V
	Emitter-Collector voltage	VECO	5	V
Operating temp.		Topr.	-20 ~ +85	°C
Storage temp.		Tstg.	-30 ~ +85	°C
Soldering temp. *2		Tsol.	260	°C

\*1. pulse width :  $t_w \leq 100\mu\text{sec}$ . Period :  $t = 10\text{msec}$

\*2. For MAX. 5seconds at the position of 2mm from the resin edge

### ELECTRO-OPTICAL CHARACTERISTICS

(Ta=25°C)

Item		Symbol	Conditions	Min.	Typ.	Max.	Unit
Input	Forward voltage	VF	IF=20mA	-	1.2	1.4	V
	Reverse current	IR	VR=5V	-	-	10	uA
	Peak wavelength	$\lambda_p$	IF=20mA	-	940	-	nm
Output	Collector dark current	ICEO	VCE=10V	-	1	100	nA
Transmission	Light current	IC	IF=20mA, VCE=5V (Non-shading)	0.5	1.5	10	mA
	Leakage current	ICEOD	IF=20mA, VCE=5V (Shading)	-	0.5	10	uA
	C-E saturation voltage	VCE(sat)	IF=20mA, IC=0.1mA	-	0.15	0.4	V
Switching Speeds	Rise time	tr	Vcc=5V, IC=2mA	-	4	-	usec
	Fall time	tf	RL=100Ω	-	5	-	usec

Collector power dissipation  
vs.  
Ambient temperature

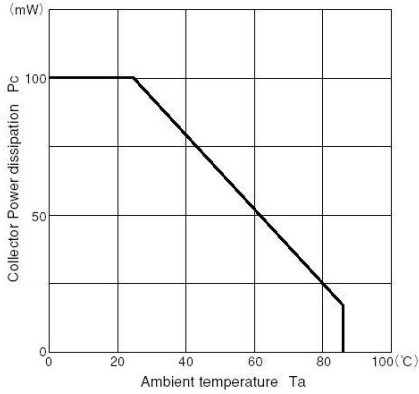

Forward current  
vs.  
Forward voltage

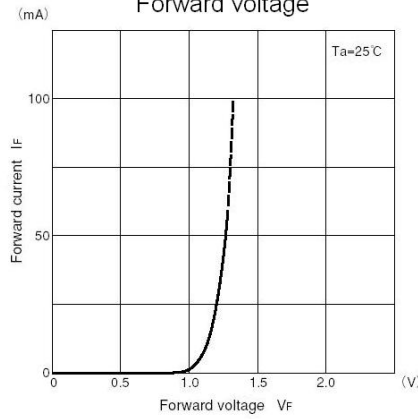

Light current  
vs.  
Forward current

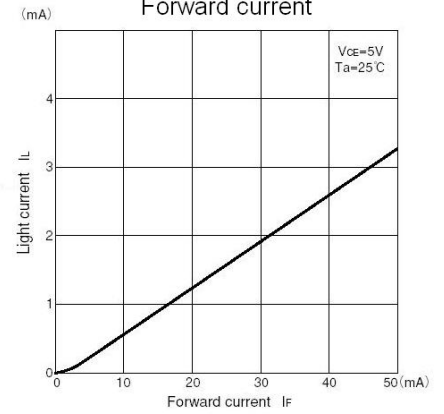

Light current  
vs.  
Collector - Emitter voltage

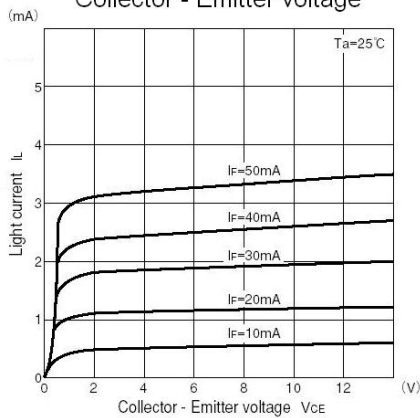

Relative light current  
vs.  
Ambient temperature

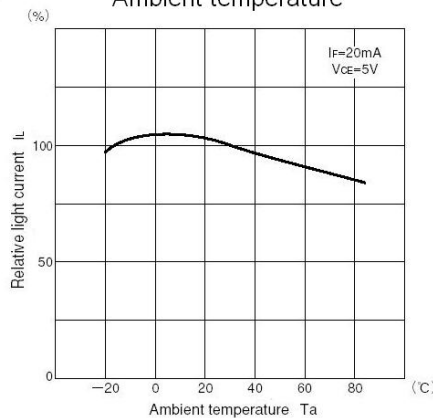

Dark current  
vs.  
Ambient temperature

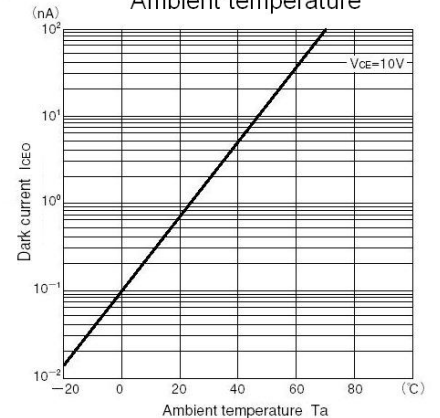

Switching time  
vs.  
Load resistance

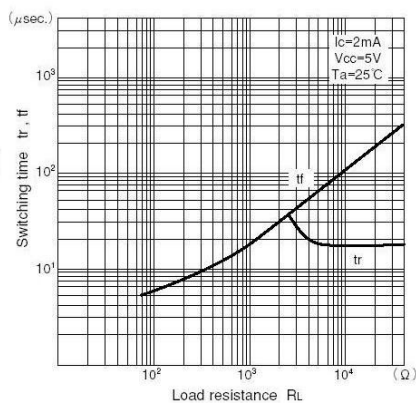

Relative light current  
vs.  
Moving distance

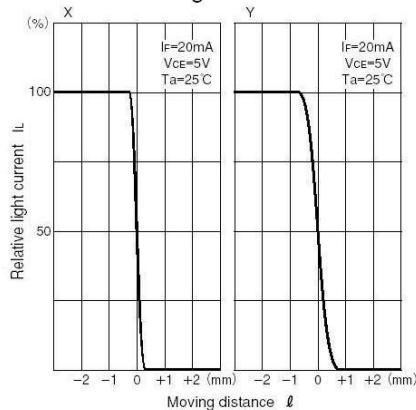

\*1 Switching time measurement circuit

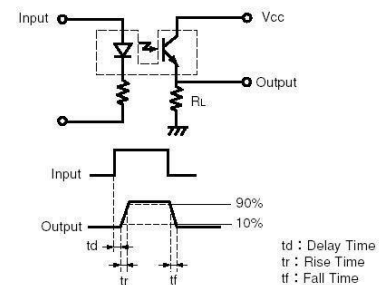

\*2 Method of measuring position detection characteristic

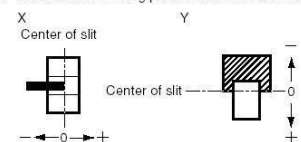

## DIMENSIONS

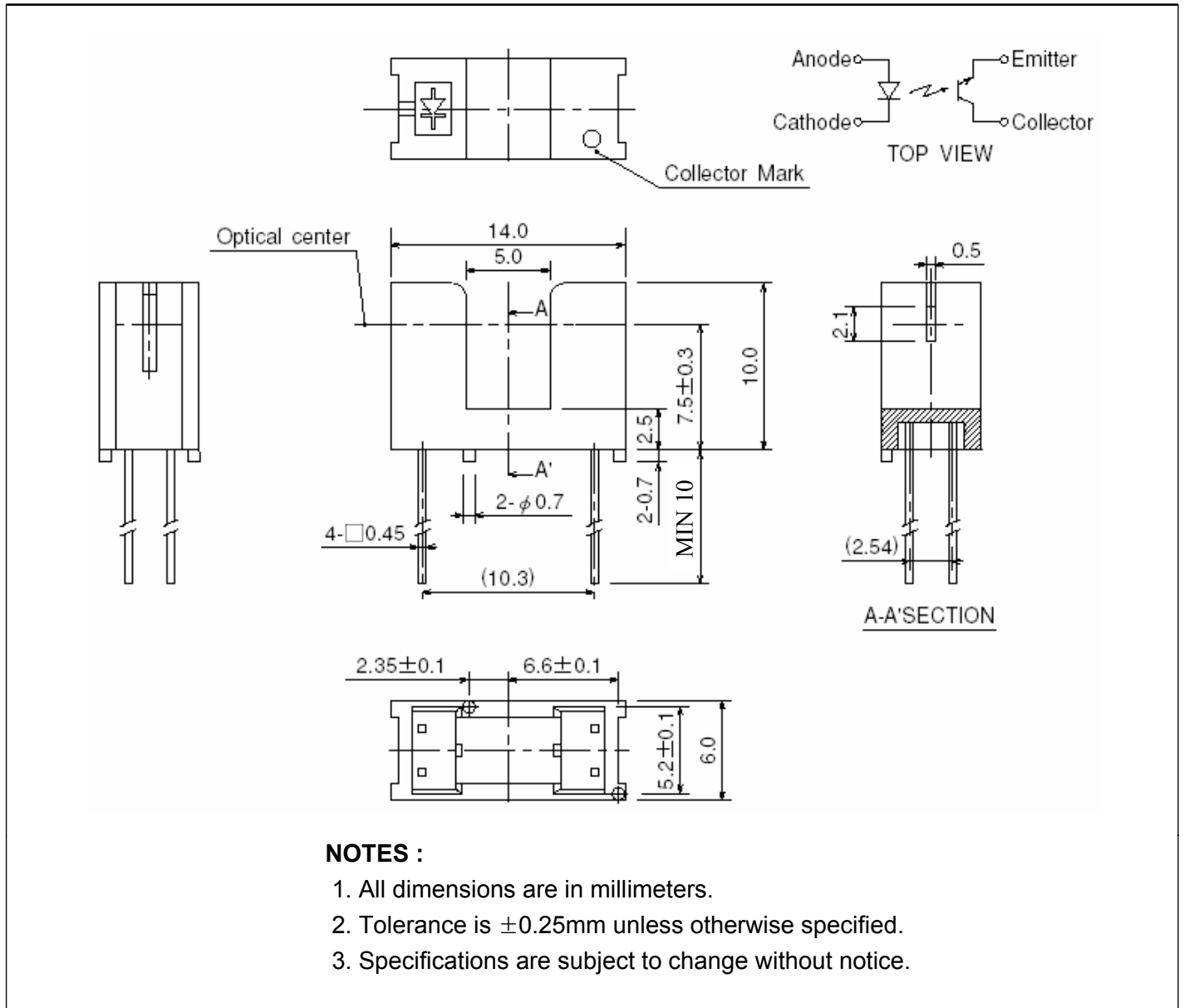

## APPLICATION CIRCUIT

