

IR Receiver Modules for Remote Control Systems

Description

The FM-26□□SM-5DN series are miniaturized receiver for infrared remote control system. The PIN Photodiode and preamplifier are assembled on lead frame. The epoxy package is designed as IR filter. The module has excellent performance even in disturbed ambient light application and provides protection against uncontrolled output pulses.

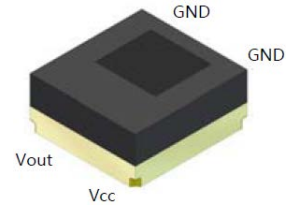

Features

- Supply Voltage Range: 2.7V to 6 V
- TTL and CMOS compatibility
- Photo detector and preamplifier in one package.
- Internal filter for PCM frequency
- Open collector output [built-in Pull-up resistor(40K)]
- Output active low
- Enhanced Immunity against all kinds of disturbance light
- No occurrence of disturbance pulses at output pin within nominal conditions.
- Short settling time after power On.(below 1msec)
- Meet RoHS

Application Circuit

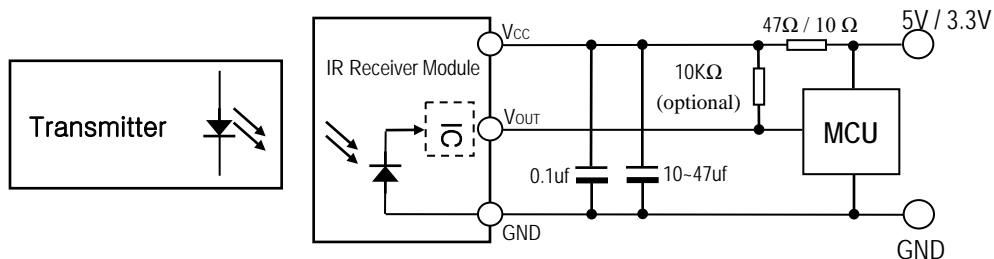

R-C filter recommended to suppress power supply disturbances.
R-C filter should be connected closely between V_{cc} pin and GND pin.

Block Diagram

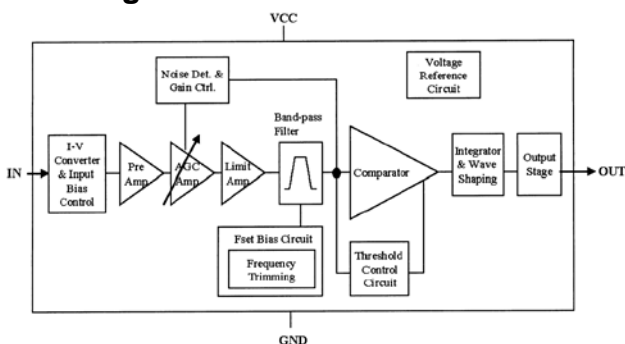

Ordering Info. (carrier frequencies)

Type	Carrier Frequency (fo)
FM-2632SM-5DN	32 kHz
FM-2636SM-5DN	36 kHz
FM-2638SM-5DN	38 kHz
FM-2640SM-5DN	40 kHz

Suitable Data Format

NEC code	◆	Sony 15bit	◆	RCS-80 code	◇
RC5 code	◆	Sony 20bit	◇	Sharp code	◇
RC6 code	◆	RCMM code	◇	High data rate code	◇
Sony 12 bit	◆	RCA code	◇	Disturbance suppression	◆

Note : ◆ : Suitable for this IR code ; ◇ : Not recommended

Absolute Maximum Ratings

(Ta = 25°C)

Parameter	Symbol	Ratings	Unit
Supply Voltage	V _{cc}	6.0	V
Output Current	I _{sink}	2.5	mA
Operating Temperature	T _{opr}	-20 ~ +80	°C
Storage Temperature	T _{stg}	-30 ~ +85	°C
Soldering Temperature	T _{sd}	260°C, Max 5 sec	°C

Electro-optical Characteristics

(Ta = 25°C)

Parameter	Symbol	Min.	Typ.	Max.	Unit	Conditions	
Supply Current	ICC	0.3	0.4	0.5	mA	No signal input	
Output Voltage	V _{oh}	V _{cc} -0.5	-	-	V	No external pull-up resistor (I _{sink} < 1mA)	
	V _{ol}	-	0.2	0.4	V		
Peak Wave Length	λ _p	-	940	-	nm		
Internal Pull-up Resistor	R _{pul}	-	40	-	kΩ		
Arrival Distance	L	±0°	12	-	-	m	Fig 1,2,3
		±30°	10	-	-	m	
		±45°	8	-	-	m	
Output Pulse width	T _{pw}	400	600	800	us	Burst Wave =600us Period = 1.2ms	

Note :

- 1) Arrival Distance Effected by Environment
- 2) While the device is operational across the temperature range, functionality will vary with temperature. Specifications are stated only at 25°C unless otherwise noted.
- 3) Stresses beyond those listed under "absolute maximum ratings" may cause permanent damage to the device. These are stress ratings only, and functional operation of the device at these or any other conditions beyond those indicated under "recommended operating conditions" is not implied. Exposure to absolute-maximum-rated conditions for extended periods may affect device reliability.

[Fig.1] Data Signal diagram

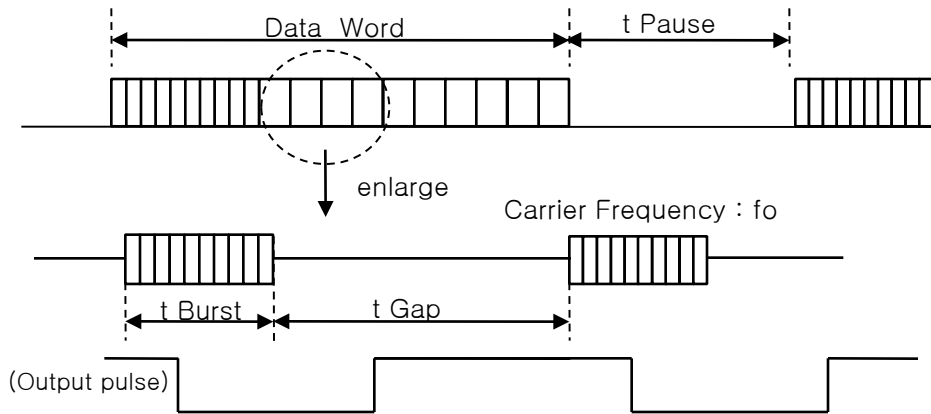

- t_{Gap} : Signal gap time between two burst in pulses of carrier. Minimum Gap Time $\geq 300\mu s$
- t_{Burst} : Length of a burst in pulses of the carrier frequency. Minimum Burst $\geq 250\mu s$
- t_{pause} : Data pause between two data words. Minimum Data Pause Time $\geq 22ms$

[Fig.2] Transmitter

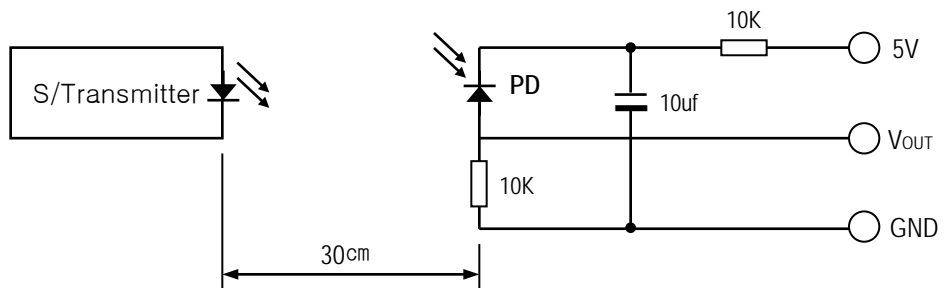

※ The specifications shall be satisfied under the following conditions. The standard transmitter shall be specified of the burst wave form adjusted to V_{out} 200mVp-p upon P_o measuring circuit Standard Transmitter

[Fig.3] Test condition of arrival distance

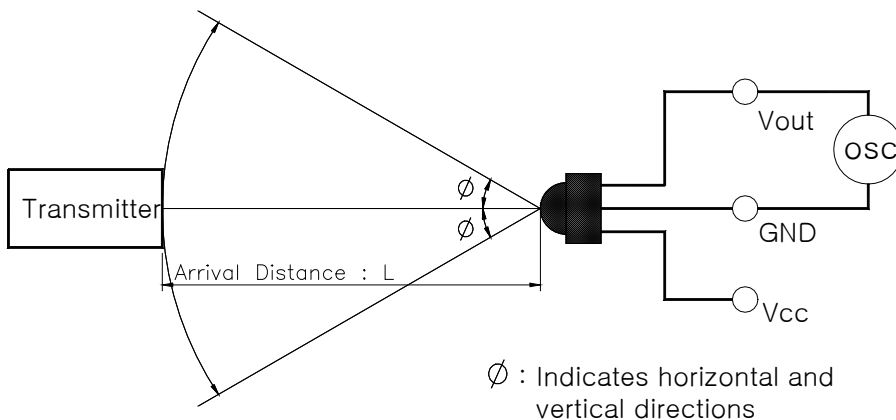

[Measurement condition for arrival distance]

☞ Ambient light source : Detecting surface illumination shall be irradiate 200 Lux under ordinary white fluorescence lamp without high frequency lighting

Electrical/Optical Characteristics

[Fig.4] Supply Current vs. Voltage

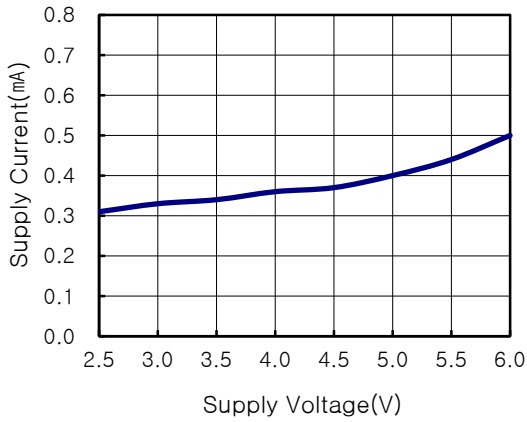

[Fig.5] Relative Spectral Sensitivity vs. Wavelength

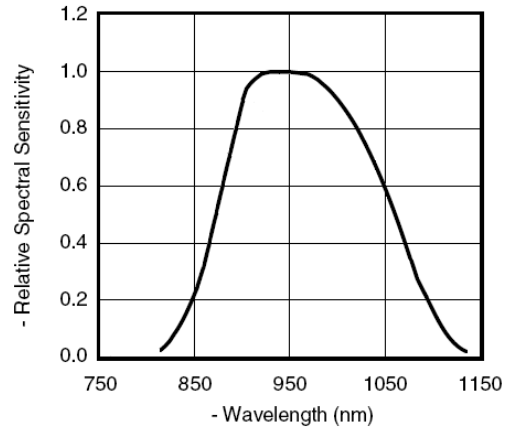

[Fig.6] BPF Fc Curve

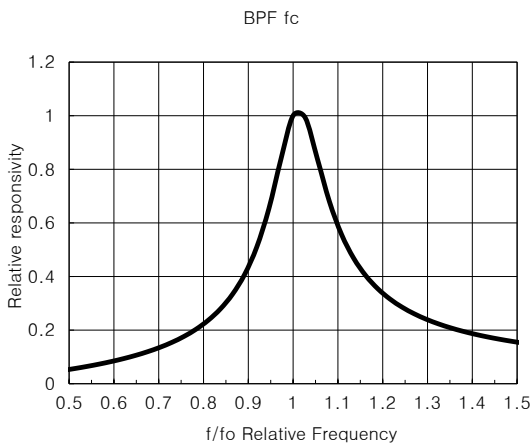

[Fig.7] Directivity

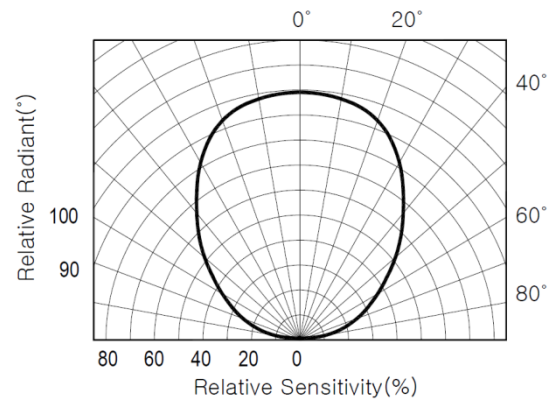

ESD Test Results

Parameter	Conditions	Specification	Results
Machine Model	C=200pF, R=0Ω	Min ±200V	>±200V
Human Body Model	C=100pF, R=1.5kΩ	Min ±2000V	>±2000V

Appearance & Dimensions

1) Package Dimension (Unit : mm)

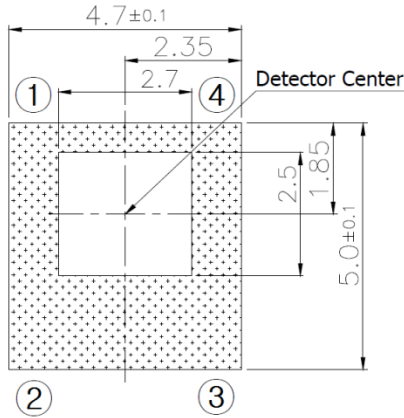

1. PIN CONFIG

- ① GND
- ② Vout
- ③ Vcc
- ④ GND

2.G.T±0.2

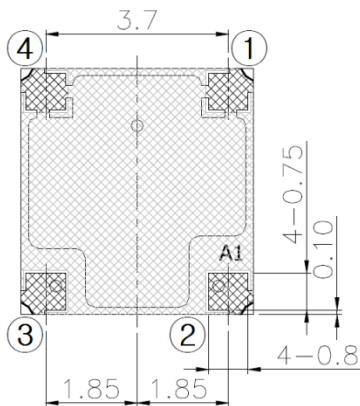
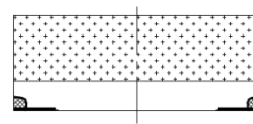
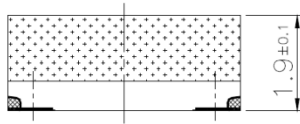

Example of Mounting drawing from Solder Side (Reference)

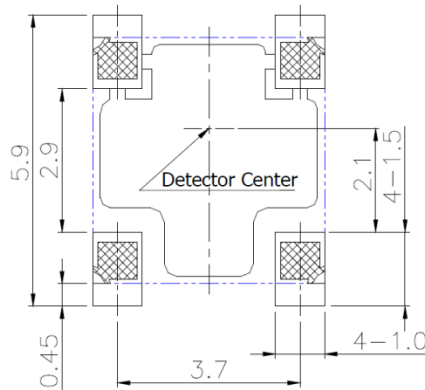

2) Marking Position : Package Back Side

3) Laser Marking of Method

No.	Classification	Remark
①	Management No.	L(5BR) , V(5DN)
②	Center Freq.	A(32) , B(36) , C(38) , D(40)
③	Year	0~9
④	Month	1~9 , X(10) , Y(11) , Z(12)
⑤,⑥	Product Lot No.	01~99

